

Figure 1a

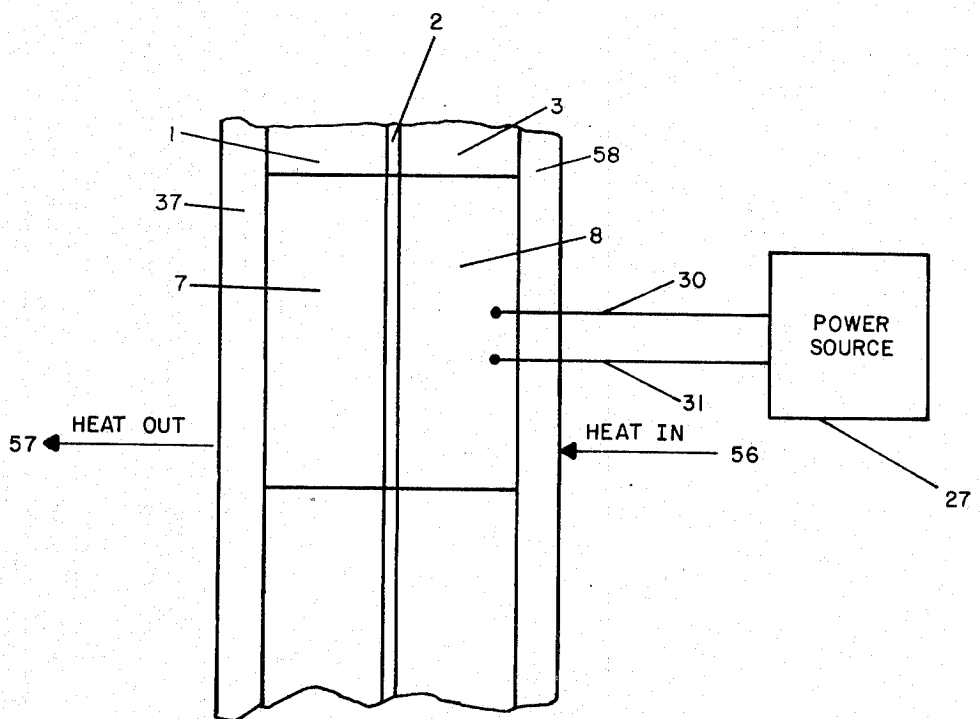

Figure 1b