

Fig. 22

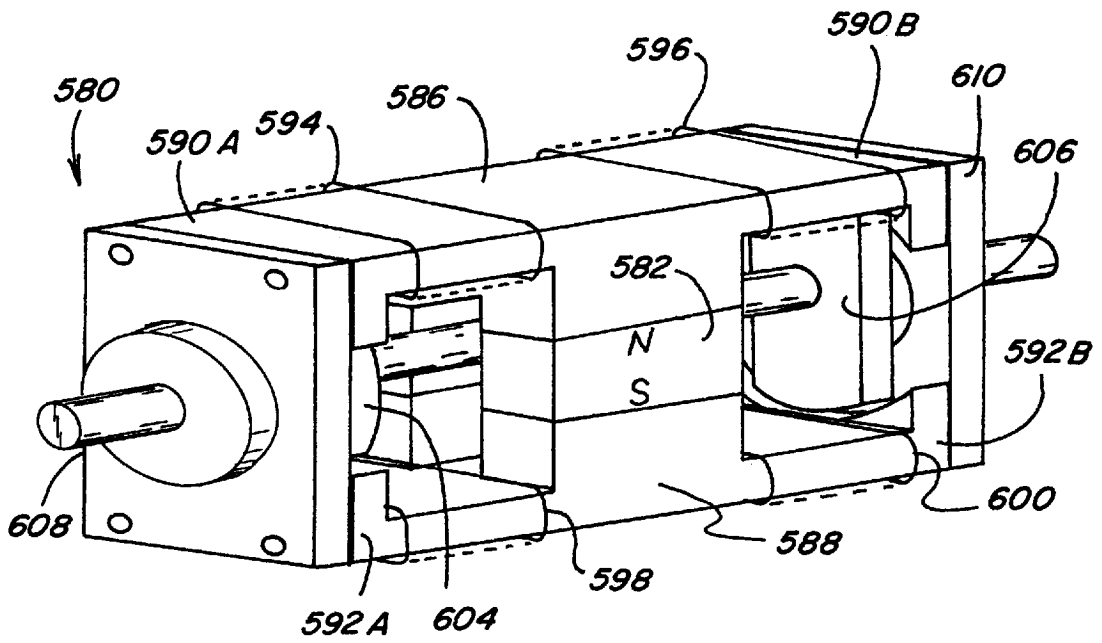

Fig. 24