

Fig. 49

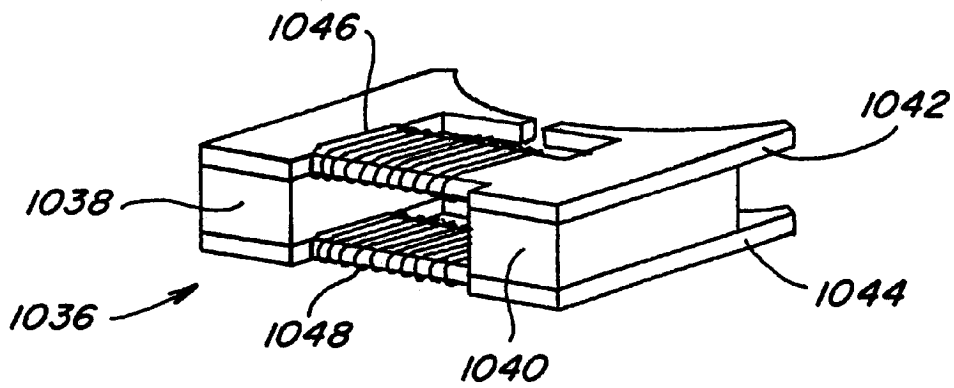

Fig. 50